

C Series

EN

User's
Manual



WELCOME

EN

Dear Valued Customer,
We are delighted to welcome you to the Voltsmile family! By choosing our energy storage batteries, you have taken a significant step towards efficiently managing your home power systems and living a more eco-friendly lifestyle.

Our energy storage batteries are designed to help you make the most of your solar power system. With Voltsmile batteries, you can store excess solar power generated during the day and use it during the night or peak hours, reducing your reliance on the grid and saving on electricity bills. Not only does this help you save money, but it also allows you to reduce your carbon footprint, as you rely less on fossil fuels and more on clean, renewable energy.

Everyone has a part to play in creating a sustainable future for our planet, and we are proud to offer products that contribute to this goal. We are committed to providing you with the highest quality energy storage batteries and exceptional customer service.

If you have any questions or concerns about your new Voltsmile storage batteries, our experts are always here to help. We want to ensure you have a seamless experience with our products and are getting the most out of your investment.

Once again, we welcome you to the Voltsmile family and look forward to serving your energy storage needs.
Sincerely,

The Voltsmile Team.

Precautions

The C Series battery systems offer many benefits, such as improved efficiency and reduced emissions. It is essential to take certain precautions to ensure safety. Here are some general precautions for using C Series battery systems:

1. Always follow Voltsmile's instructions and guidelines for using and maintaining the battery system.
2. Wear appropriate personal protective equipment, such as insulated gloves and safety glasses, when working with high-voltage battery systems.
3. Ensure that the battery system is installed correctly and grounded and that all electrical connections are secure.
4. Do not attempt to disassemble or modify the battery system, as this can result in electric shock or other serious injuries.
5. If the battery system is damaged or shows signs of malfunction, such as leaking or swelling, stop using it immediately and seek professional assistance.
6. Avoid exposing the battery system to extreme temperatures or environmental conditions that could cause damage or degradation.
7. Always turn off the power supply before connecting or disconnecting the battery system, and never touch the electrical contacts with bare hands or metal tools.

These precautions ensure that C Series battery systems are used safely and effectively in various applications.

WARNING!



**THIS SYSTEM CONTAINS
HIGH-VOLTAGE BATTERY**



WARNING:

Installation and maintenance should only be carried out by trained professionals. We do not undertake any consequences or related responsibility because of violation of safety operation or violation of design, production and equipment safety standards.



CAUTION:

1. It is required to charge the battery at least once every six months. For this charge, maintenance ensures the SOC is higher than 90%.
2. The connection of the power connector, grounding point, power cable and screw are suggested to be checked yearly. Ensure there is no loose, broken, or corrosion at the connection point. Check the installation environment, such as dust, water, insect and more, to ensure it is suitable for the battery system.
3. If the battery is stored for a long time, it must charge every six months, and the SOC should be higher than 90%.



In case a battery (normal condition or damaged) needs disposal or needs recycling, it shall follow the local recycling regulation (i.e. Regulation (EC) Number 1013/2006 among European Union) to process and use the best available measures to achieve relevant recycling efficiency.

Before Start :

1. Please read this user's Manual thoroughly.
2. The C Series must be installed against load bearing wall.
3. The C Series modules weighs at least 42kg, and we recommend that at least two people for the installation.
4. Ensure that the site is suitable for the installation, considering factors such as space, ventilation, and accessibility.
5. Conduct a thorough risk assessment to identify potential hazards and develop appropriate mitigation measures.
6. Choose a official supplier of Voltsmile that can provide genuine battery systems and professional installation services.
7. Ensure that the electrical infrastructure can handle the high voltage and current of the battery system and that all electrical connections are properly installed and grounded.

Tools for installation:

Electric Screwdriver or Screwdriver
(Phillips Head)





CAUTION

Place the cabinet on firm and level ground, ensuring it is positioned securely and away from any fire or water sources to prevent accidents. Additionally, keep it out of reach of children to avoid any unintended harm or mishandling.

Height: 1750mm
Depth: 630mm
Width: 600mm
Weight: 130 kg

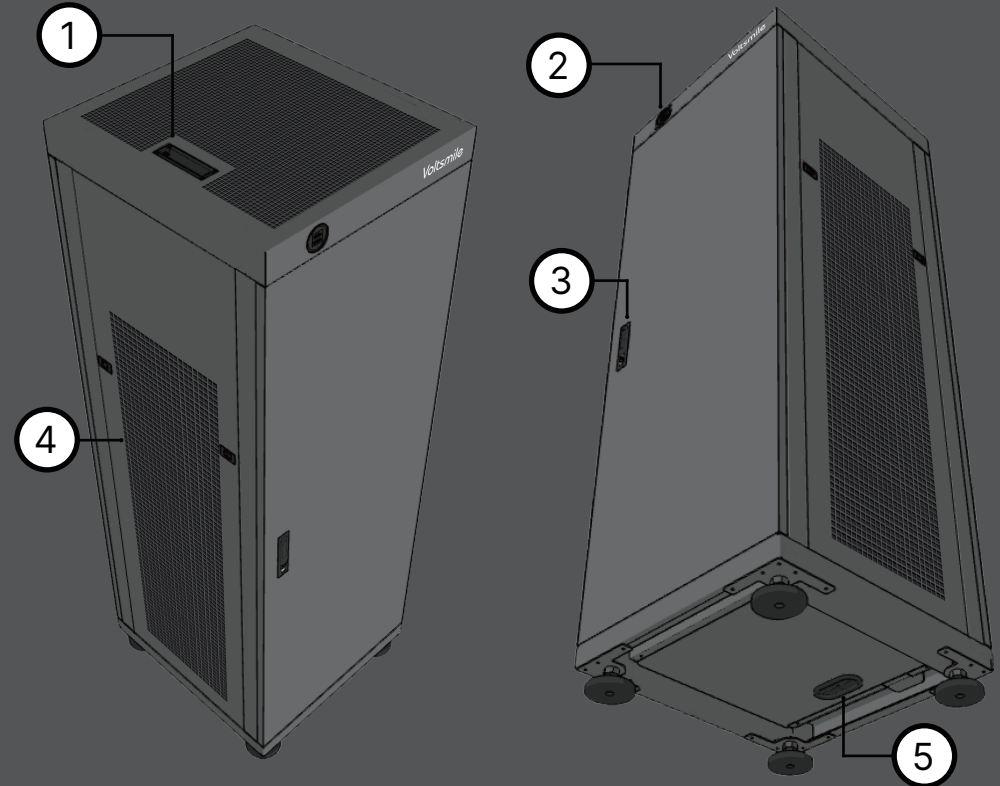

1. Wi-Fi Antenna.
2. SOC Indicator.
3. Door Handle.
4. Side Panel.
5. Line Out Terminal.

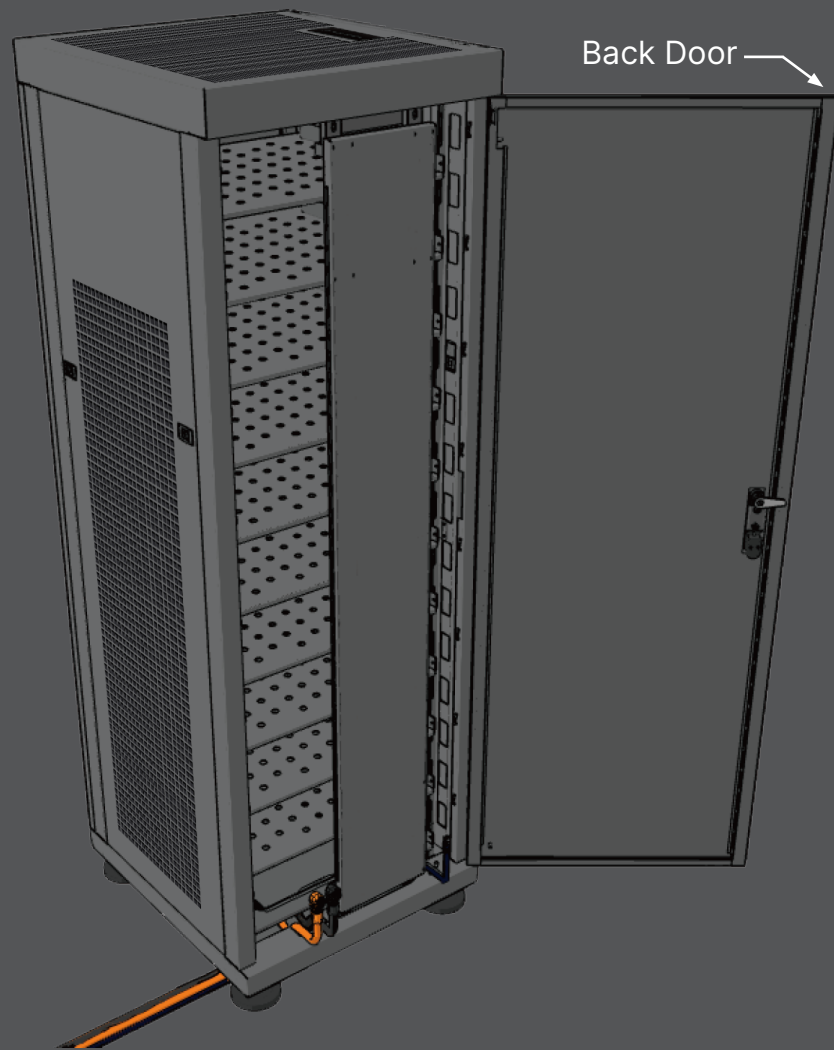

1. Open the back door and route the power and data cables through the Line Out terminal. (Parallel cluster data cables if needed)



2. Open the front door and insert the PDU unit.

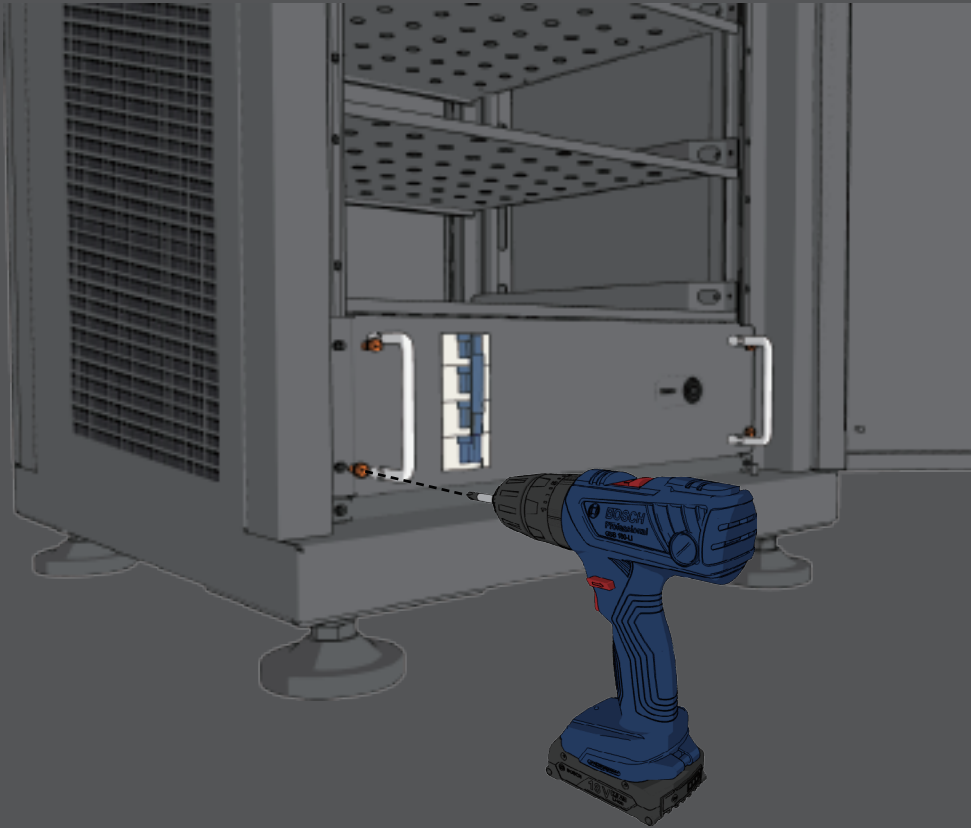

3. Secure the PDU with four screws.

4. Connect all cables to the rear of the PDU.

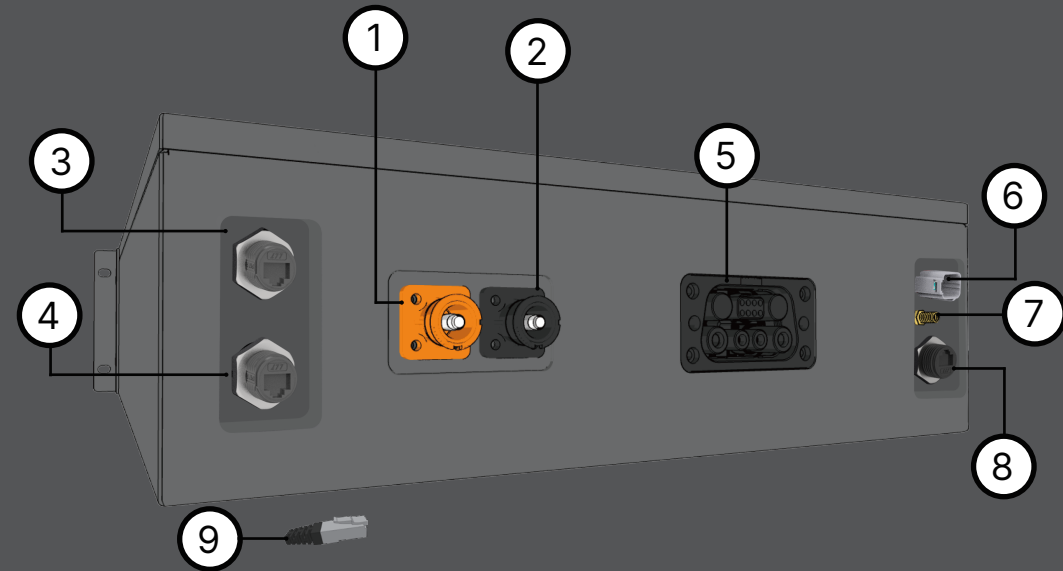

1. DC out +.

2. DC out -.

3. Cluster data IN.

4. Cluster data OUT.

5. RPC busbar terminal.

6. Display Terminal.

7. Wi-Fi Antenna Terminal.

8. Inverter data link.

9. Single cluster end point.*

*Please note that the 9. Single cluster endpoint must be connected to the 4. Cluster data OUT port if the C system is the only cluster. In multiple cluster setups, the 9. Single cluster endpoint must be connected to the 4. Cluster data OUT port of the last cluster.

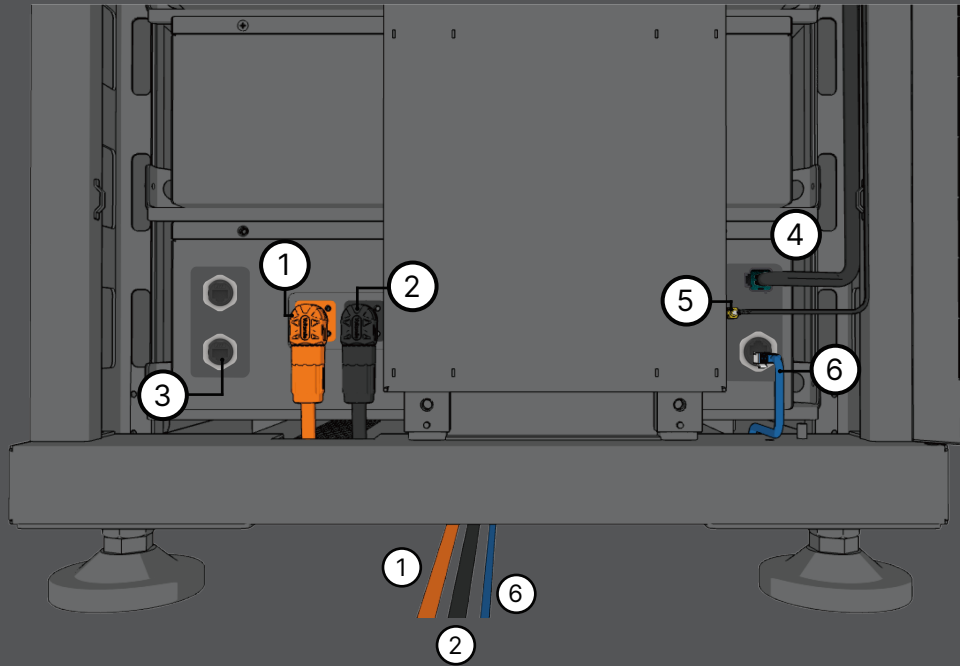

1. DC Out +.
2. DC Out -.
3. Single cluster end point.
4. Display Terminal.
5. Wi-Fi Antenna.
6. Inverter Data Terminal.

5. For a single cluster installation, the cable must be connected according to the configuration illustrated above. This connection ensures proper communication and power distribution within the cluster, optimizing performance and stability. It's essential to follow the specified wiring pattern to avoid potential issues such as data loss or hardware malfunctions. Properly securing the cable and verifying the connection after installation are crucial steps to ensure the system functions as intended.

CAUTION:

Before cutting the power or disconnecting any cables, it is crucial to properly shut down the entire system. This ensures that all processes are safely terminated, and data integrity is maintained. Abruptly cutting the power or disconnecting cables without following proper shutdown procedures can lead to system damage, data loss, or corruption. Taking the time to turn off the system correctly will prevent potential issues and ensure that the equipment remains in good working condition.

6. For a multiple cluster installation, you first need to define the MASTER and SLAVE clusters. Begin by designating which cluster will serve as the MASTER and which will act as the SLAVE. Next, follow the connection guidelines provided below, ensuring that each cluster is correctly linked according to the specified configuration. It is crucial to double-check all connections and settings.



Two Clusters Connection diagram:

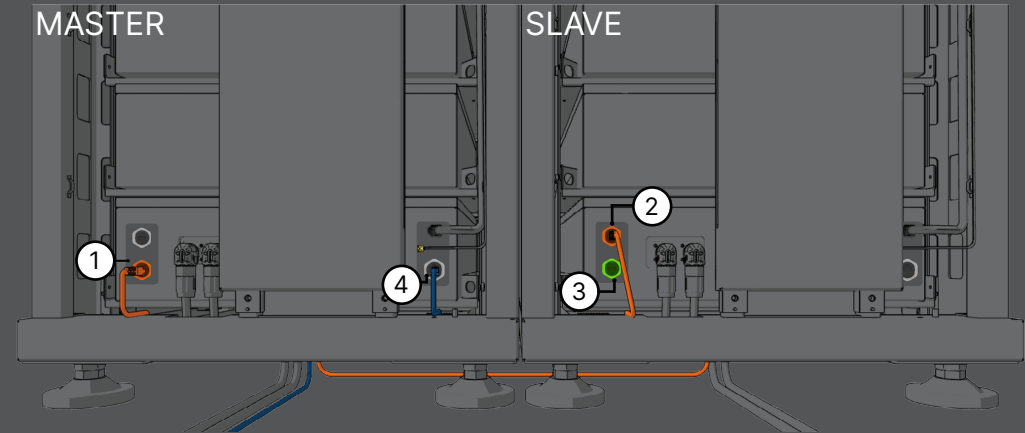

To establish a proper connection, first connect the MASTER 1.Cluster data OUT port to the SLAVE 2.Cluster data IN port using an Ethernet cable.

Ensure that the 3.Single Cluster endpoint is securely connected to the SLAVE Cluster data OUT port.

Please note that only the MASTER Cluster Inverters data link should be connected directly to the inverter. This setup will ensure seamless data flow and communication between the master and slave clusters while maintaining the correct configuration for the inverters.

Three or more Clusters Connection diagram:

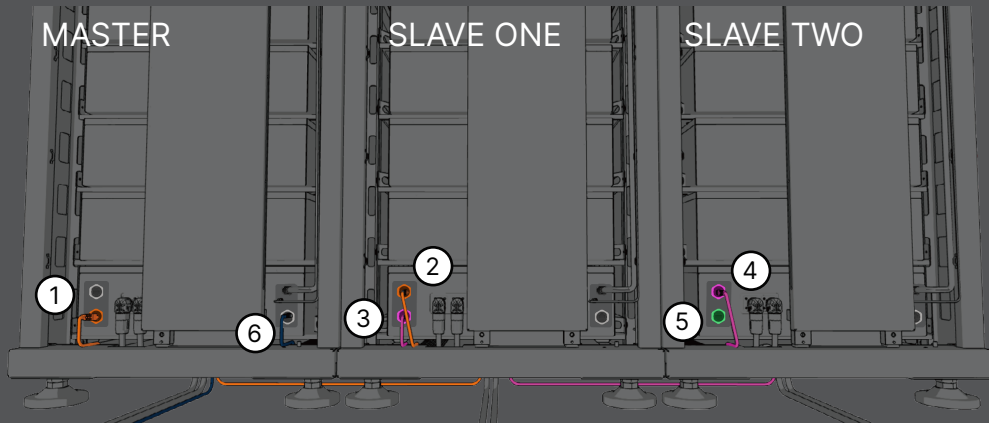

Connect the MASTER 1.Cluster data OUT port to the SLAVE ONE 2.Cluster data IN port using an Ethernet cable.

Then connect 3.Cluster data OUT port to the SLAVE TWO 4.Cluster data IN port.

Ensure that the 5.Single Cluster endpoint is securely connected to the SLAVE Cluster data OUT port.

Connect 6. Inverter data link to the inverter.

7. Before installing the battery modules, it is crucial to ensure that the Main Breaker is in the OFF position. This step is vital for your safety and the protection of the electrical system. Always double-check that the Main Breaker is off before proceeding with any further steps in the installation.

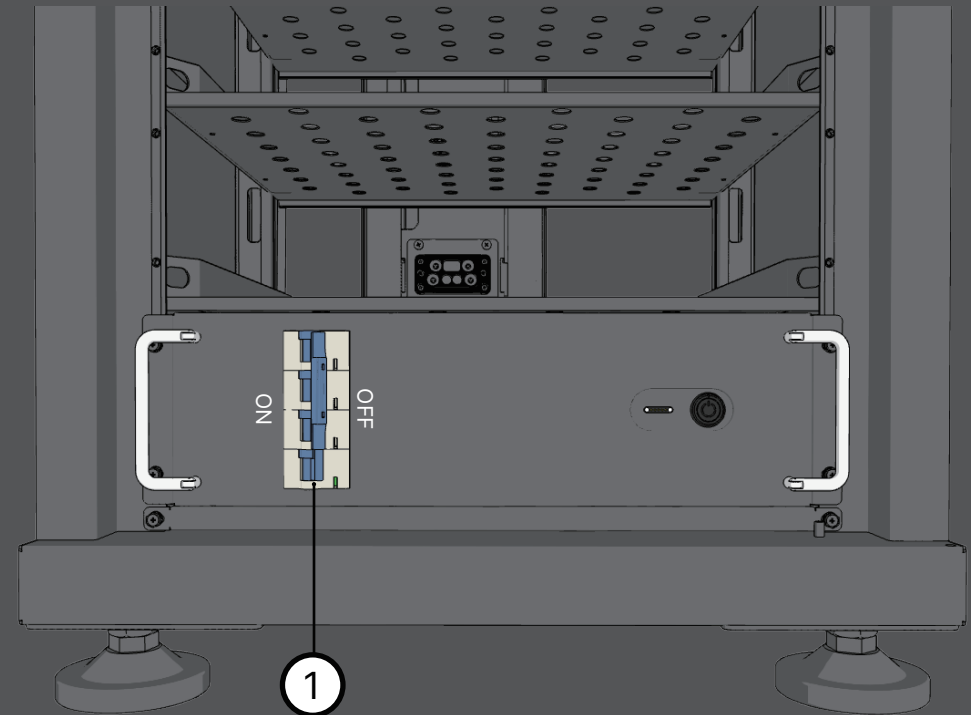

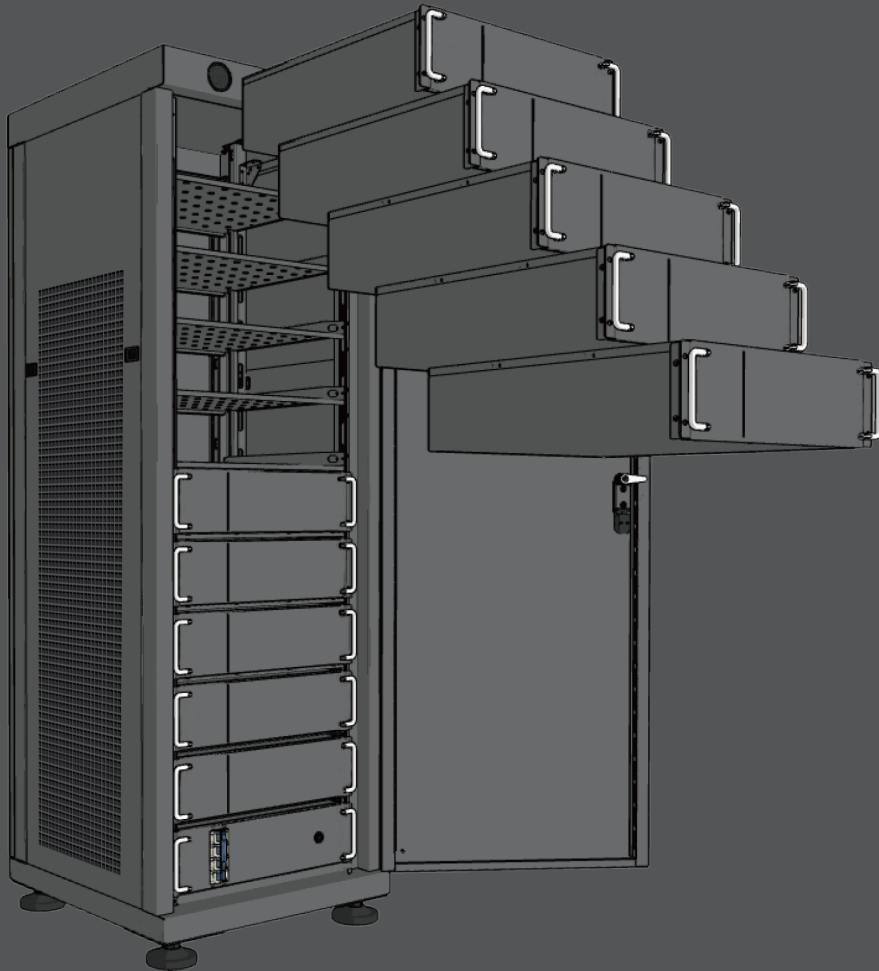

8. Position the cabinet in the designated area, and install the C battery modules sequentially from the bottom to the top.

Do not mix batteries in one system from different pallets!

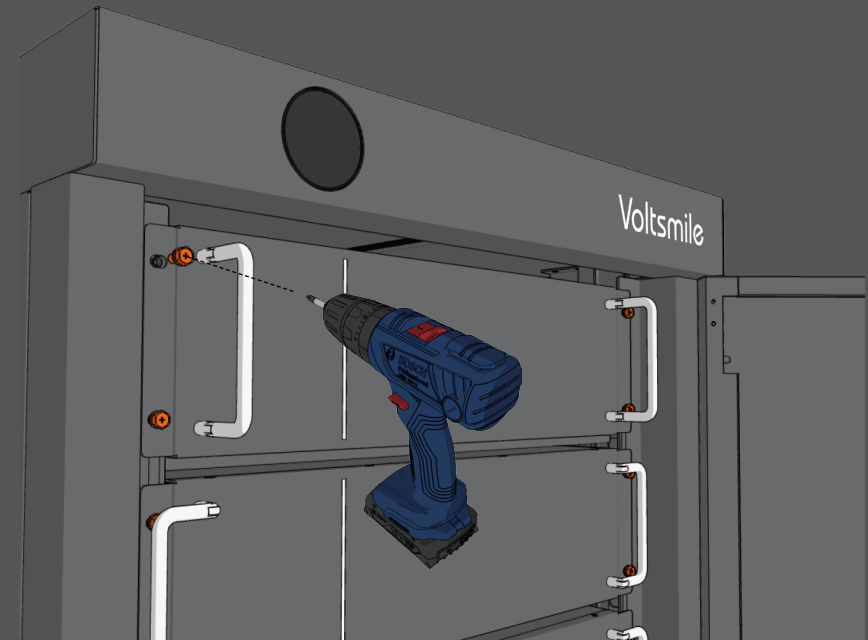

9. Secure all the batteries with screws provided.

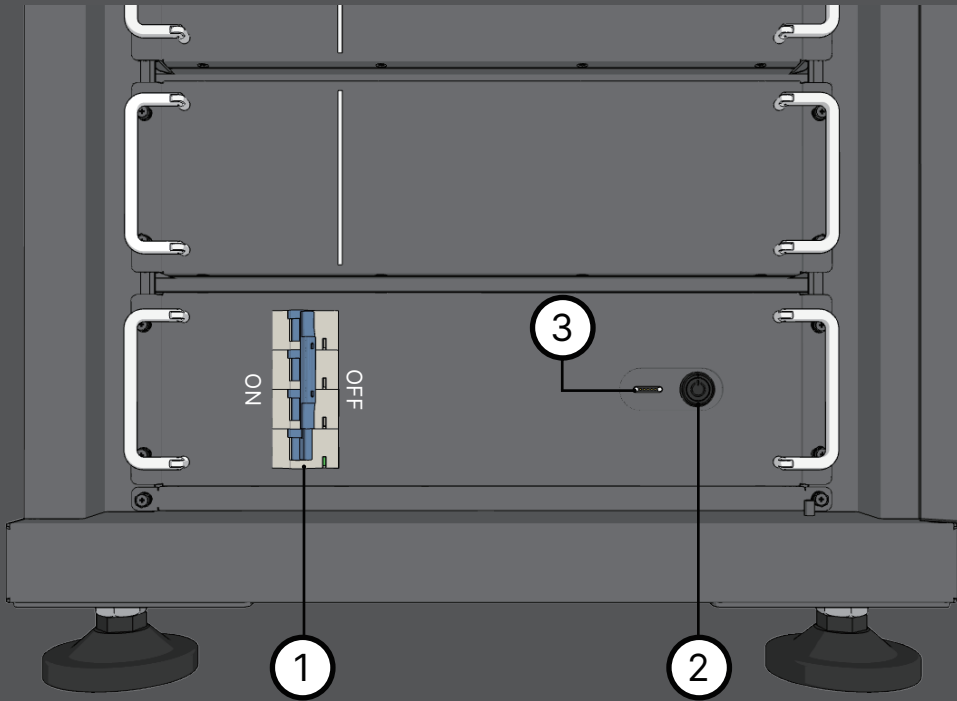

1. Main Breaker.
2. Power Switch.
3. Data Port. *

To Switch ON the C system:
1. Turn Main Breaker to ON position.
2. Turn ON Power Switch.

To Switch OFF the C system:
1. Turn OFF Power Switch.
2. Turn Main Breaker to OFF position.

*The 3.Data Port is exclusively for system updates and debugging purposes, requiring the expertise of trained professionals to use with the BMS portal software. For system updates and accessing system information, the C system can be conveniently operated via Wi-Fi and the internet. Additionally, dedicated apps are available for both iOS and Android platforms, allowing for easy management and monitoring of the system.



After turning on the C system, the LCD display should light up and show the current State-Of-Charge along with the current voltage. It is normal to hear some mechanical clicking sounds; these indicate that the PDU is performing a self-check and that the relays are turning on. The entire startup process should be completed within 30 seconds.

CAUTION:

Please ensure that all connections are properly secured, with no loose or incomplete connections. Verify that there are no exposed wires, as these could pose a safety hazard.

Additionally, make sure all battery modules are securely installed in their designated positions. Taking these precautions will help ensure the system operates safely and efficiently.

Apps & Settings

- 1 Find Voltsmile by Udan Tech on either Apple App Store or Google Play store.

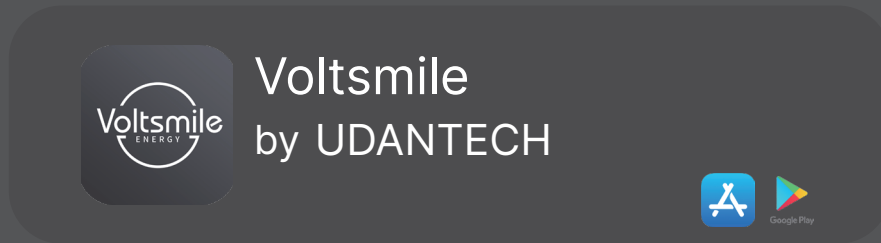

- 2 After installation, please create a user account, and follow the instruction to login.



- 3 After login, please check for app update under the user info tab, and make sure you are running the latest app version.

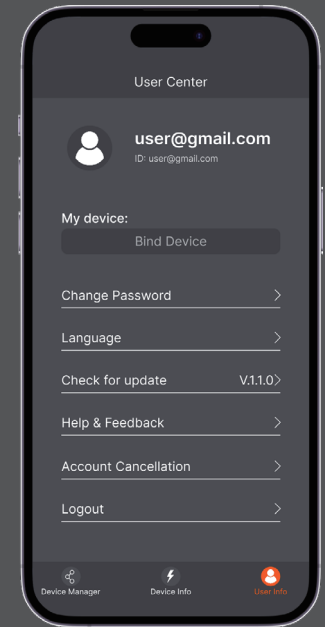

- 4 Scan the unique QR code for your C Series battery system and bind it to your account. (Please be in Bluetooth range with the C Series)

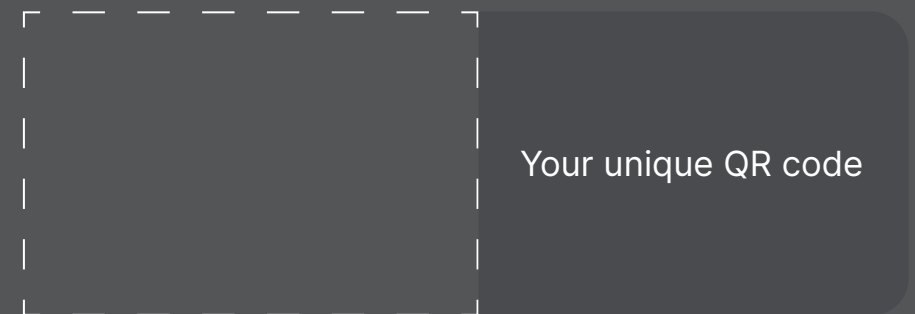

- 5 After scanning the QR code, App will ask for Bluetooth connection permission on your phone. After enabling Bluetooth, you will be greeted with the config page where we recommend configuring your WiFi at this stage, or if you choose not to, you can check your battery stats by clicking Dashboard, but only within Bluetooth range.



- 6 If you choose to connect to your WiFi network, please click WiFi Config. The App will then ask WiFi password for your network. (C Series only work with a 2.4 GHz WiFi network.)

- 7 Once connected to the WiFi, you can monitor your C Series System anywhere worldwide and upgrade its firmware wirelessly.

- 8 All done, enjoy!

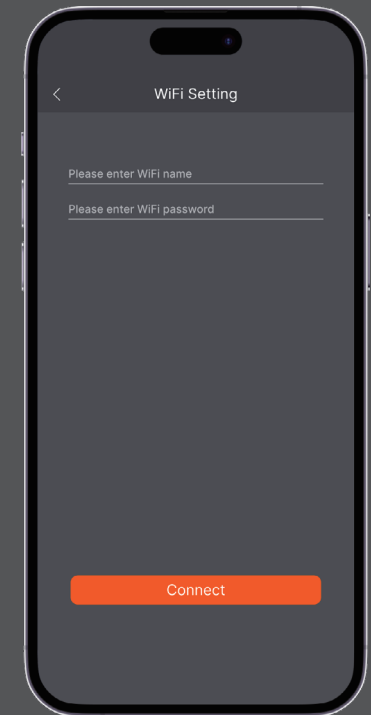



In conclusion, setup your battery system according to the guidelines provided in this manual will ensure its optimal performance and longevity. Regular monitoring, proper handling, and adherence to safety protocols are key to preventing issues and maximizing efficiency. Your battery system is designed to provide reliable energy storage, whether for daily use or backup power during emergencies. Should you encounter any challenges or require further assistance, our dedicated customer support team is ready to help. Thank you for choosing our product, and we look forward to supporting your energy needs for years to come.



Voltsmile Team

